



JT Racking Systems are used as a safety rack to secure and restrain gas cylinders. They are typically used in hospital or laboratory gas storage rooms but can be utilized wherever securing of cylinders is needed.

These gas rack frames have been seismically certified and engineered to meet the California Building Code 2010 (CBC) and the strict requirements of the Office of Statewide Health Planning and Development (OSHPD). The design of these structural frames allow for them to be used within essential facilities.

OSHPD OPA # OPA-2878-10

Features:

- Meets NFPA Cylinder Restraint Requirements.
- Secure 1-8 Full Size Cylinders per Rack.
- Right and Left-Armed Racks Available for Multiple Cylinders in One Area.
- Modular Design Allows Unlimited Growth of Cylinder Quantity.
- Secures to Floors with Hilti® KwikBolts-TZ. (included.) ½" ID x 7" Length.
- Organizes Gases by Types, and Maintains Them in Rows.
- Greatly Increases Storage Capacity of Both New and Existing Floor Space.
- Dual Restraint Required In Seismic Areas.
- 2" x 2" x 1/8" Tube Steel, Hot Rolled, P&O.
- 5/16" Steel Welded Link Chain. Electrically Zinc Plated. Weight Load Limit: 1,900 lbs.
- 5/16" Zinc Plated Carabineer Hooks. Weight Load Limit: 520 lbs.
- All Joints Wrap-Welded and Polished, Mounting Holes Drilled.
- Assembly Finished with Exterior Grade Polyurethane Powder Paint, Baked-On Finish, Standard Color: Black (Custom Color Available)



Manufactured in California with US Steel and US Chain



Distributed By:



"Your Compressed Gas Equipment Specialists"

1-800-537-3090

www.certifiedmedicalsales.com



Dimensions

- Model 1D2W-L

OSHPD OPA # OPA-2878-10
Seismically Certified and Engineered

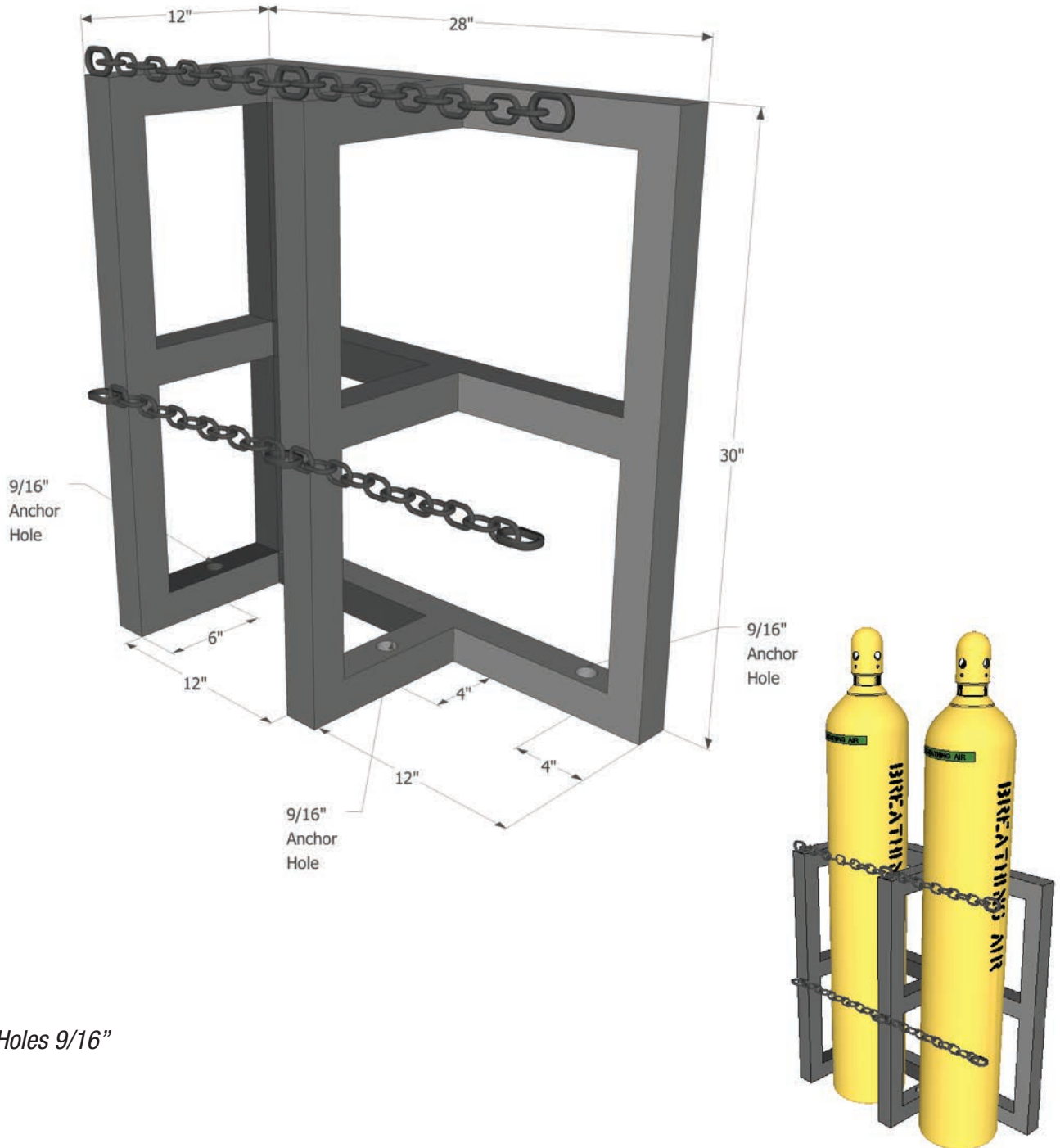

- Mounting Holes 9/16"

Distributed By:



"Your Compressed Gas Equipment Specialists"

1-800-537-3090
www.certifiedmedicalsales.com